



# COMPOSING 3-D SHAPES

Name \_\_\_\_\_

Score \_\_\_\_\_

CD:20

Color the 3-D shapes used in each question.

1)

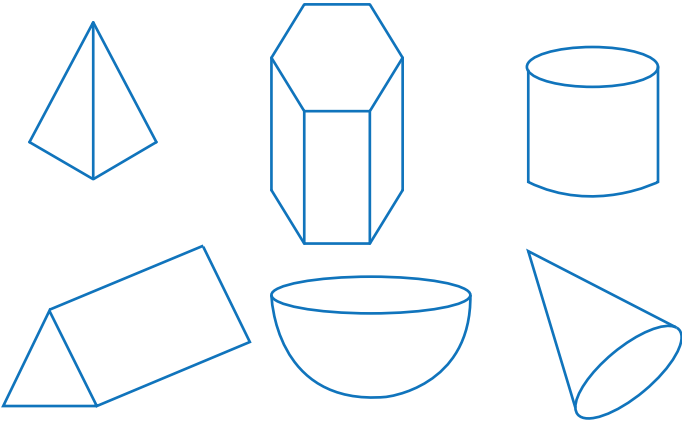
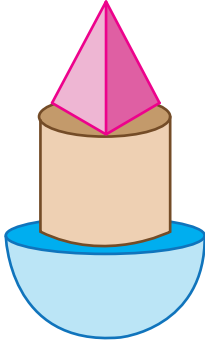

2)

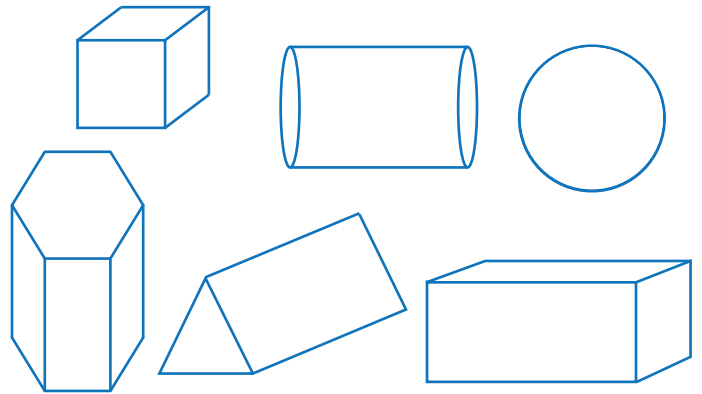
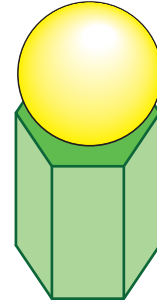

3)

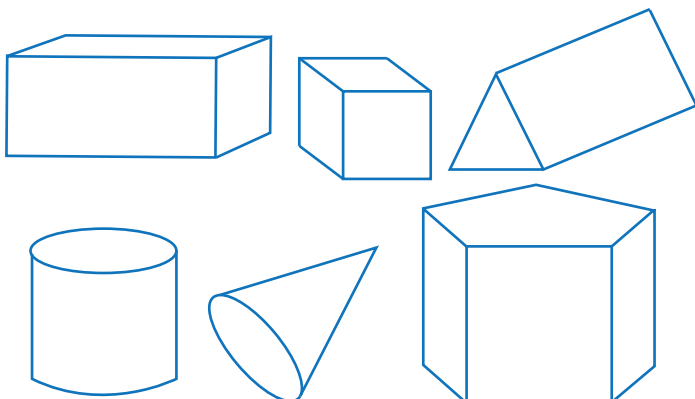
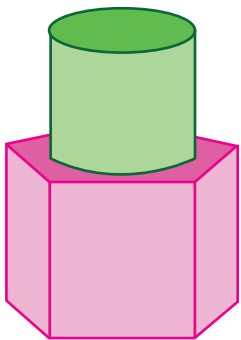

4)

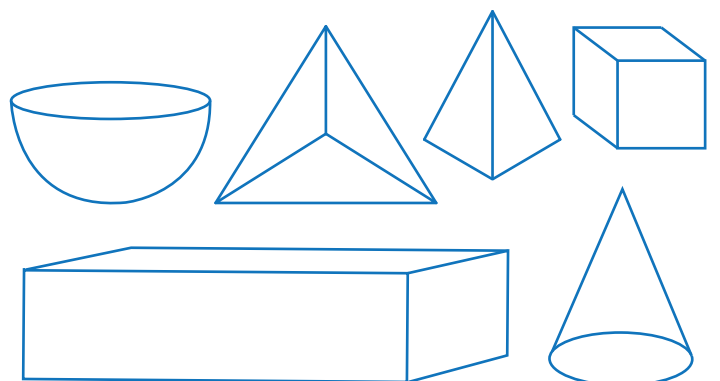
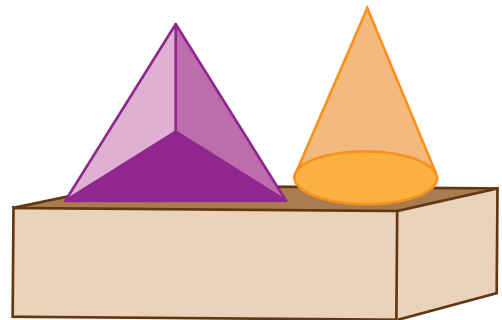



# COMPOSING 3-D SHAPES

Name \_\_\_\_\_

Score \_\_\_\_\_

## Answer key

CD:20

Color the 3-D shapes used in each question.

1)

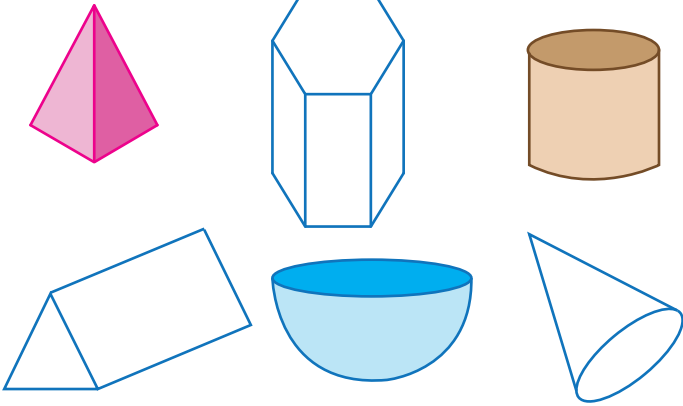
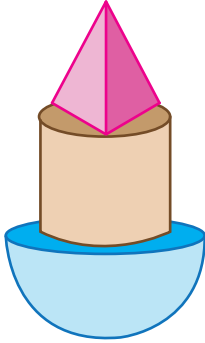

2)

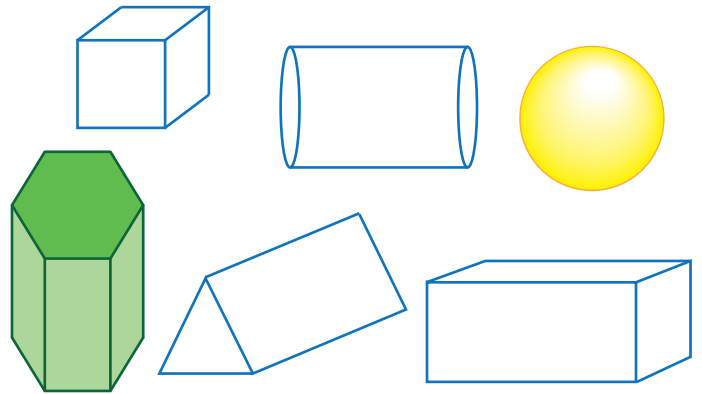
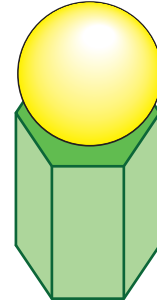

3)

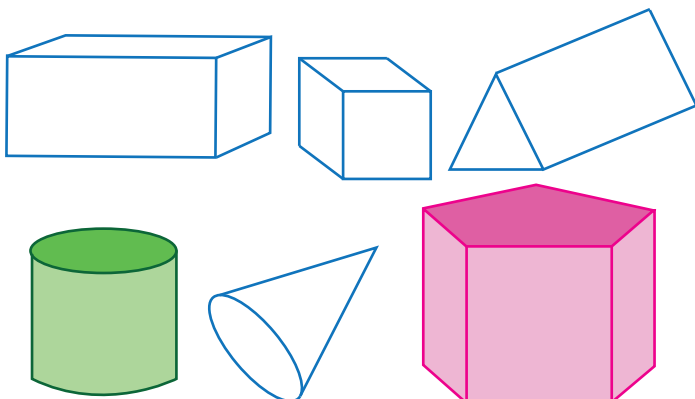
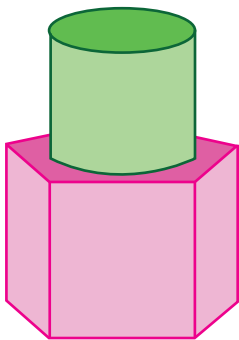

4)

